

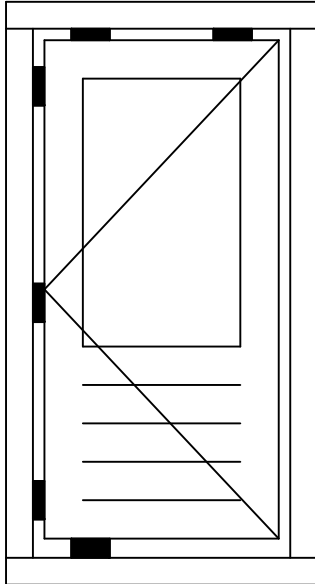

## Draaiende delen stellen

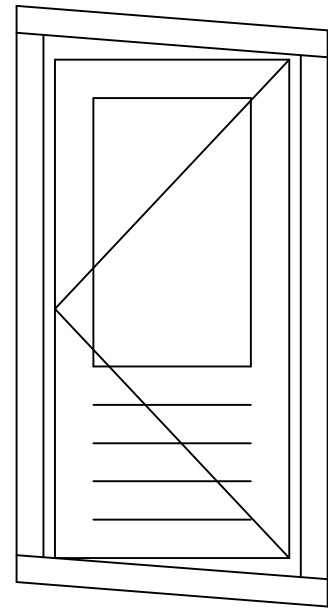

**Kozijn-stijl sluitzijde te laag**

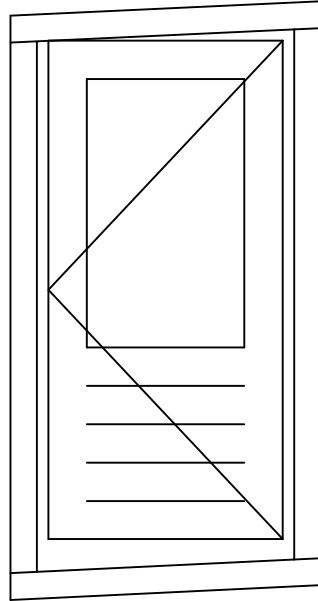

**Kozijn-stijl sluitzijde te hoog**

**Zorg dat bij de draaiende delen de hang, sluit en boven naden altijd evenwijdig lopen !!!!  
Dus geen waterpas MAAR NADEN CONTOLEREN !!!**

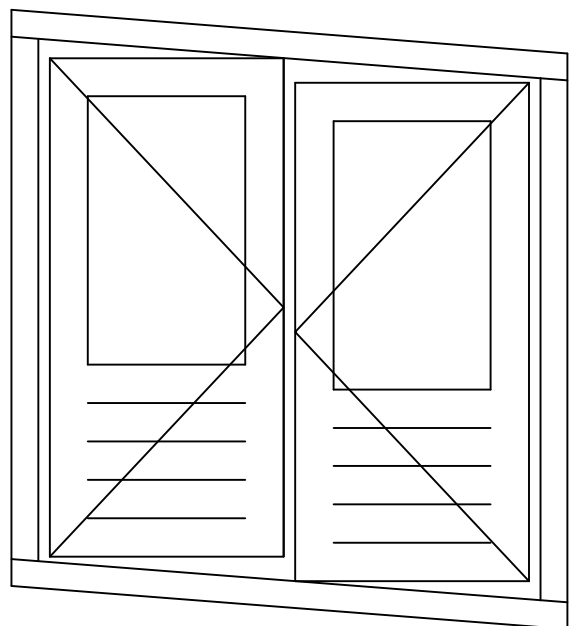
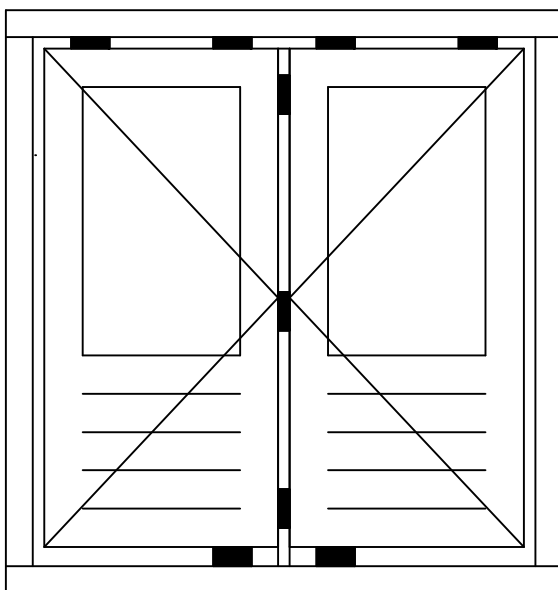



# Lood en raamdorpelsteen

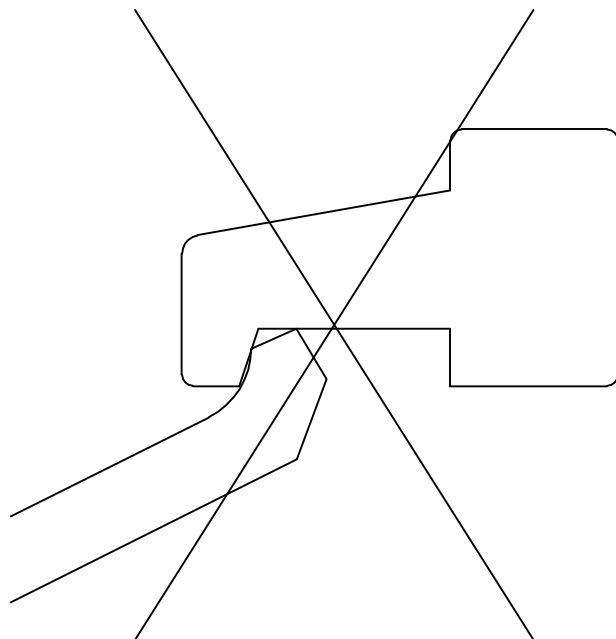
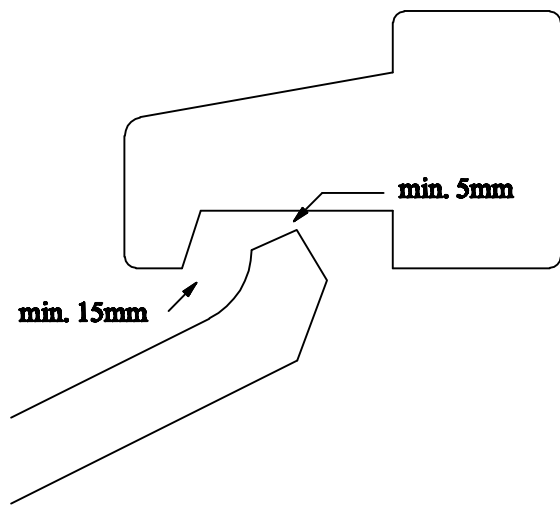
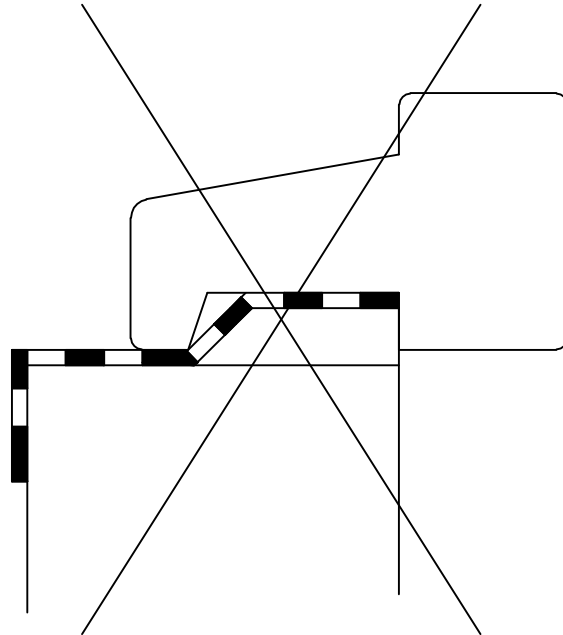
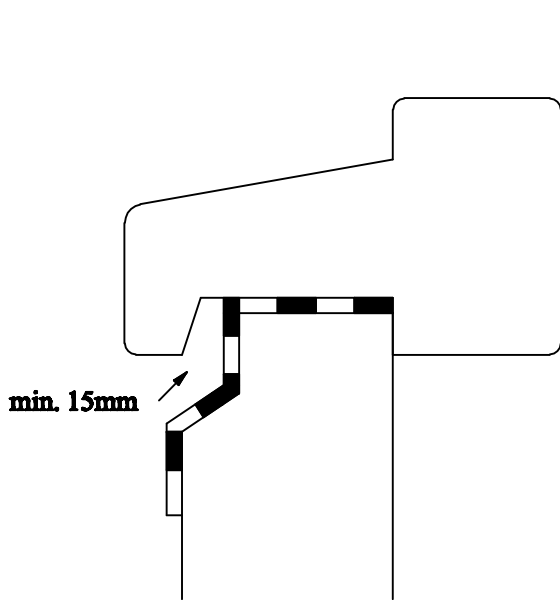



# Bestrating

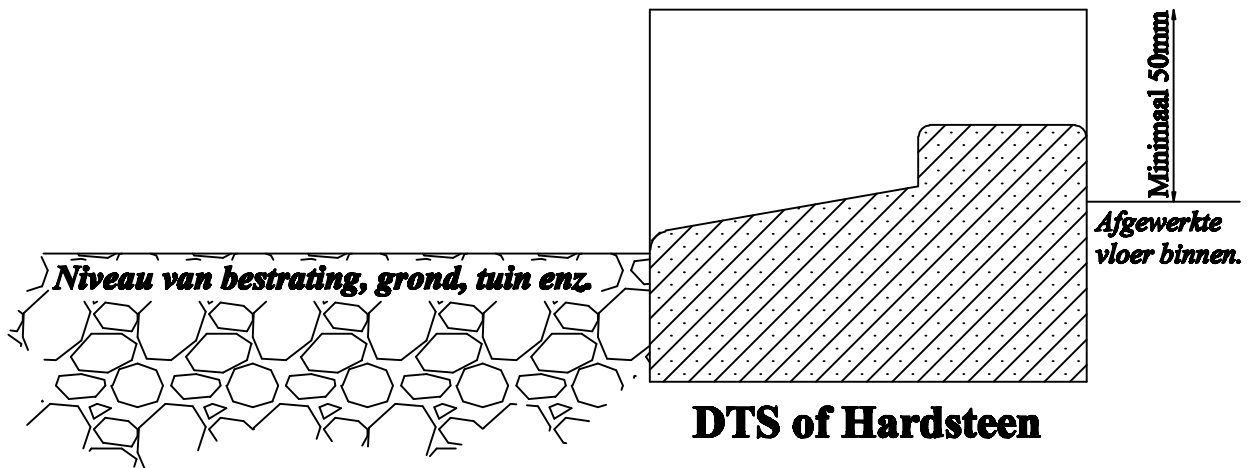
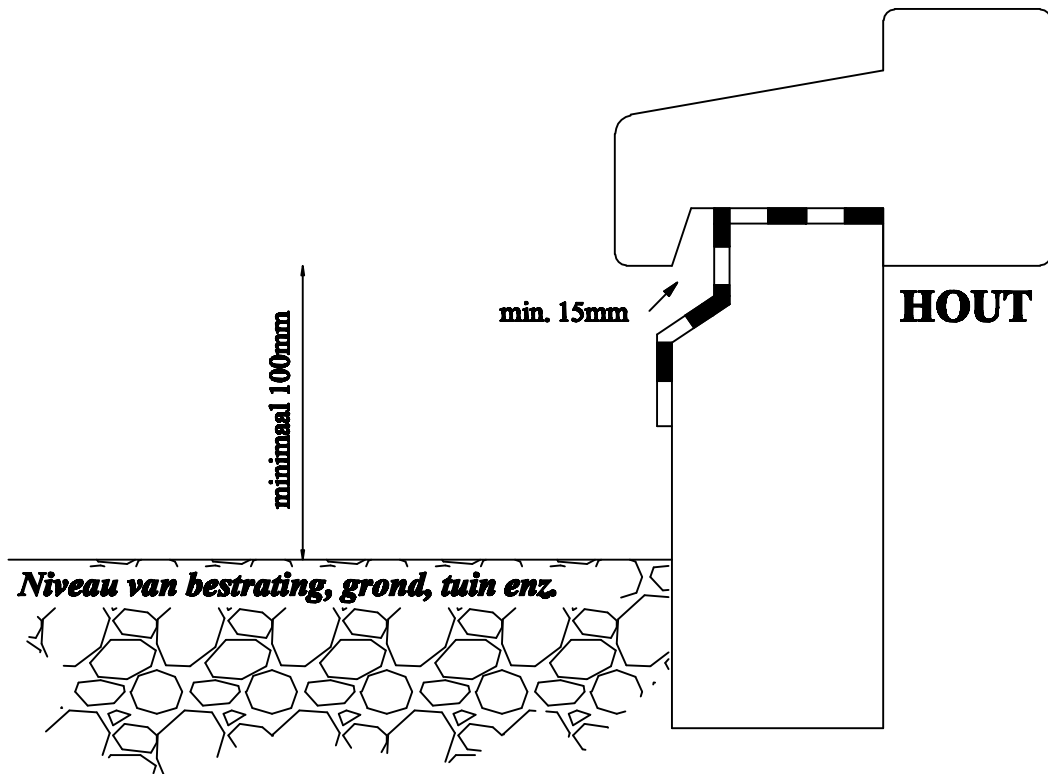
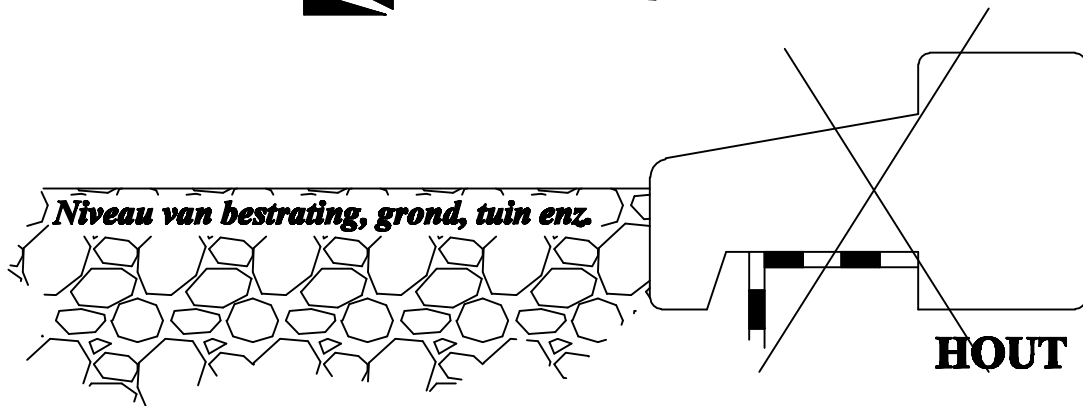



# Plaats van de verankermiddelen

